

Optimus 360 Configuration and Commissioning

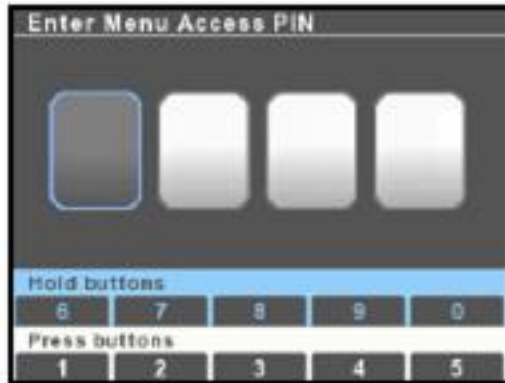

Figure D-5.

All setup and configuration tools are reached from the Dealer Menu, which authorized installers can access with a four digit PIN code (if you don't have a code contact SeaStar Solutions technical support). From the main run screen, press and hold **Menu** until you see the PIN entry screen.

Use the buttons to enter your four digit PIN code. Press the buttons briefly for digits 1-5, press and hold for digits 5-9.

If you enter the code incorrectly you will exit the screen and be placed into the user menu. Press and hold **Menu** again to get back to the PIN entry screen.

Once you have entered the correct code you will go directly to the Dealer Menu. You won't need to enter the code again unless you cycle system power.

NOTICE

The Dealer Menu can be unlocked when faults are active. Faults are suppressed during setup and system updates.

Optimus 360 System Purging

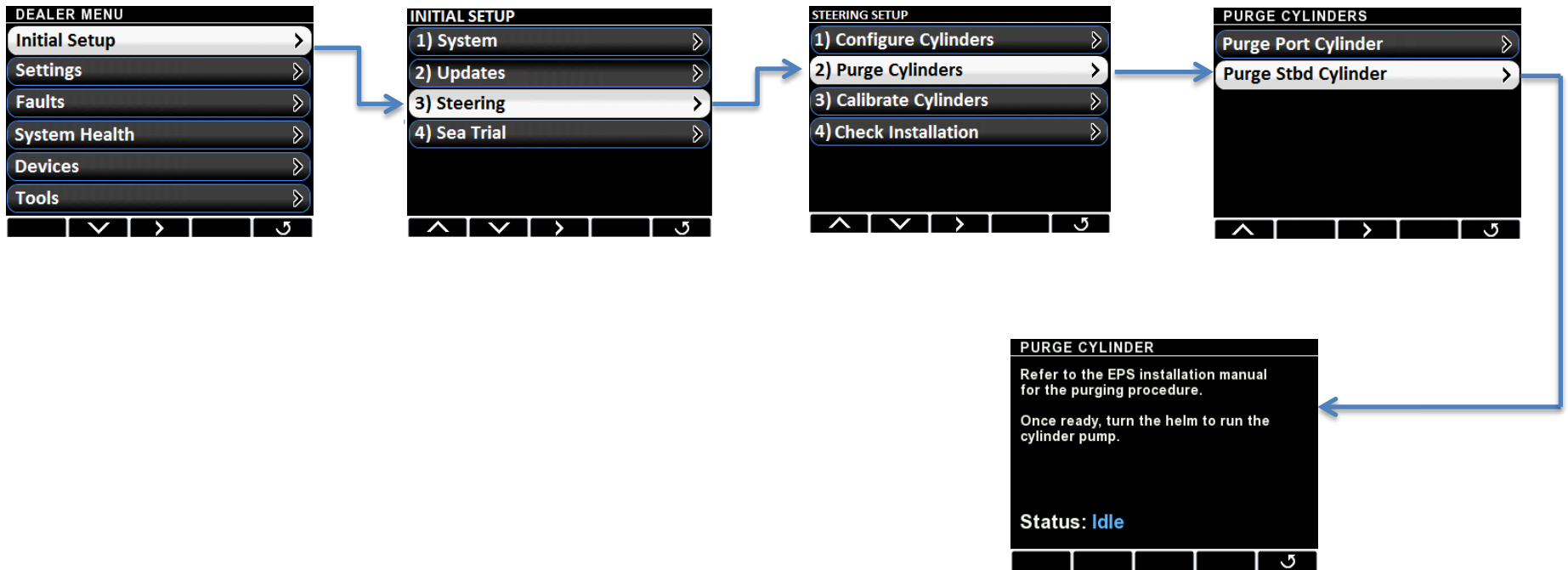

NOTICE

If the helm has been steered since the ignition was turned on the system will not enter purge mode. You will need to cycle power again.

Note: System purging follows the same procedure for all cylinder types.

NOTICE

When purging you will be required to turn the helm AND maintain fluid level in the pump reservoir. The pump can empty the reservoir quickly while purging. When the fluid level in the reservoir drops to the MIN mark, stop turning the steering wheel and refill the reservoir to the MAX mark. DO NOT ALLOW THE FLUID LEVEL TO GO BELOW THE MIN MARK.

Optimus 360 System Purging

Purging the Steering System

To purge the EPS system you will require the following supplies and equipment:

- Optimus EPS Steering Fluid, HA5482. A typical new installation will require about one US gallon (3.8l) of fluid, supplied with your core component kit.
- Purge hose kit HA5486 (15ft [4.5m]) or HA5487 (30ft [9m]).
- A 1/2" (13 mm) open end wrench.

Preparation

On the engine being purged, remove the two black caps on the SmartCylinder bleed fittings, and the black cap on the corresponding power steering pump bleed fitting. Connect the purge hose as shown. Open all three bleeders 1-1/2 to 2 turns.

CAUTION

The system is bled one engine at a time. Since the engine being bled will move over its full steering range, it may hit the inactive (not being bled) engine. Move the engine not being bled as far outboard as possible to assure the engines do not collide. If the inactive engine will not move manually open the service valve for that engine.

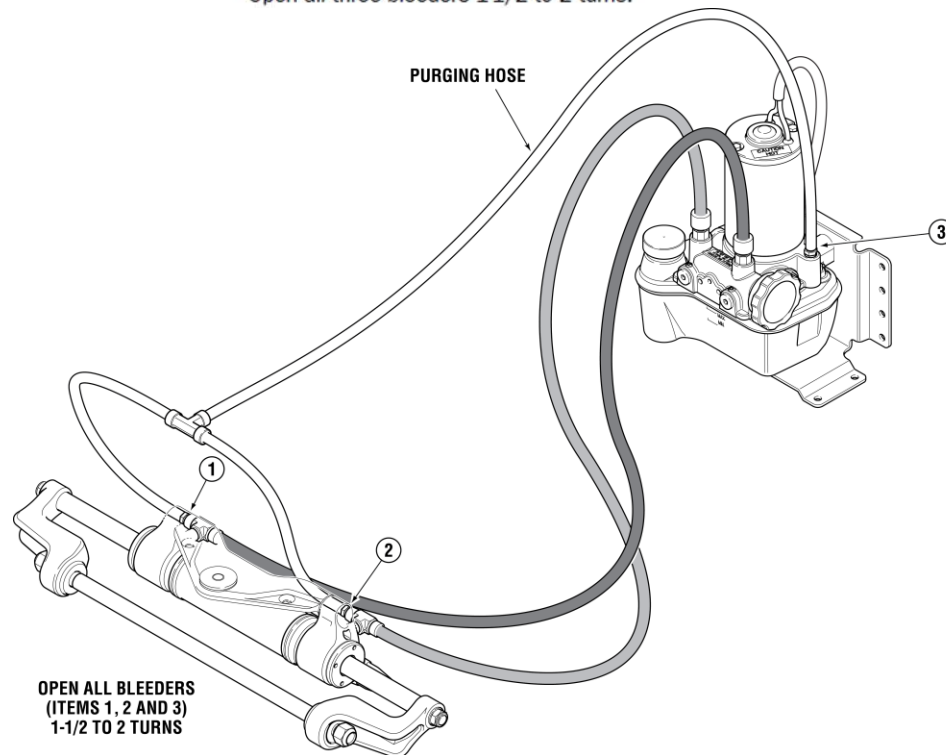

Optimus 360 System Purging

The Purging Process

NOTICE

If the engine being purged requires the cylinder steering angle to be limited – such as to avoid interference – the cylinder must be purged, calibrated, and the stroke setting changed with the cylinder support brackets removed.

1. Move the engine(s) not being bled as far outboard as possible. This may require opening the service valve for that engine.
2. Center the engine being bled and close the service valve for that engine.
3. Fill the reservoir on the Hydraulic pump being bled to the MAX level. DO NOT OVERFILL as air coming back during purge may cause the fluid to overflow.

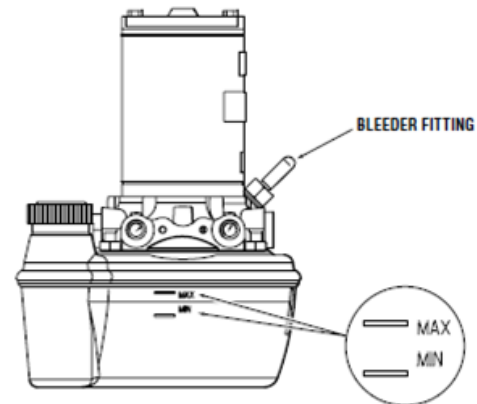

Figure 7-6.

4. Double check that the purge hose is connected to the CORRECT pump and cylinder for the engine being bled. Failure to do so may damage the bleed hose.
5. Verify that all three bleed fittings are open 1 ½ to 2 turns.
6. Power on the Optimus system.

CAUTION

DO NOT turn the helm at this time or the hydraulic pump will run. Should this accidentally occur power off the system for 3 seconds then power back on. This will stop the pump.

Optimus 360 System Purging

7. On the CANtrak display, navigate to **Dealer Menu > Initial Setup > Steering > Purge Cylinders** to access the Purge Cylinders menu.
8. Select the cylinder you wish to purge and press **>** to enter Purge Mode.
9. Turn the helm one direction to start the purging process. The pump will run as the wheel is being turned. Continue turning the wheel until the cylinder reaches the end of travel. Verify the pump oil level frequently.
10. Turn the wheel in the opposite direction until the cylinder reaches the end of travel. Verify the pump oil level frequently.
11. Repeat steps 12 & 13 until no more air bubbles appear in the purge hose. Verify pump oil level frequently
12. Close both cylinder bleeders. DO NOT close the pump bleeder yet.
13. Open the service valve for the engine being purged and move the engine by hand approximately 3 inches.
14. Close the service valve.
15. Re-open the cylinder bleeders 1 ½ to 2 turns.
16. Repeat steps 12 & 13 until no more air bubbles appear in the purge hose. Verify pump oil level frequently.
17. Close all three bleed fittings, remove the purge hose and replace the bleeder protective caps.
18. Press **↻** to return to the Purge Cylinders menu.
19. Move the purge hose to the cylinder and pump to be purged.
20. Repeat steps 8-18 for the other cylinder.
21. If you need to calibrate the SmartCylinders, proceed to the next step. Otherwise, press **↻** repeatedly to exit. You will be prompted to perform a key cycle in order to exit the steering setup.

TIP: When purging is complete the cylinder should have 3/8" or less of movement when physically trying to shake the engine back and forth.

Optimus 360 System Calibration – Color CANTrak

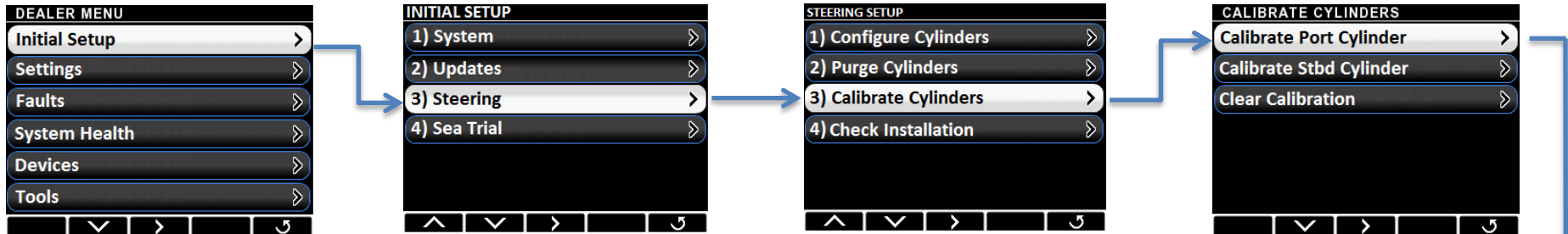

CALIBRATE CYLINDER

Refer to the EPS installation manual for the calibration procedure.

Once ready, turn the helm towards port until the status reports hardstop reached. Then turn the helm towards stbd until the status reports hardstop reached.

Status: **Idle**

Note: System calibration follows the same procedure for all cylinder types.

⚠ WARNING

DURING THE CALIBRATION PROCEDURE THE ENGINES WILL MOVE THE FULL TRAVEL OF THE STEERING RANGE. CONFIRM THERE ARE NO OBSTRUCTIONS IN THE PATH OF THE ENGINES. IF THERE IS AN OBSTRUCTION REQUIRING STROKE REDUCTION, THE CYLINDER MUST FIRST BE CALIBRATED WITH THE SUPPORT BRACKETS REMOVED.

⚠ CAUTION

The Optimus EPS system must be fully purged of air before calibration is attempted. Any air in the system will prohibit calibration and will cause the system to exhibit faults.

Optimus 360 System Calibration – Color CANtrak

Calibrating the SmartCylinders

1. Open the starboard service valve, move the starboard engine as far outboard as possible, then close the service valve again. This will prevent collision when the port engine moves during calibration.
2. On the CANtrak display, navigate to **Dealer Menu > Initial Setup > Steering > Calibrate Cylinders** to access the Calibrate Cylinders menu.

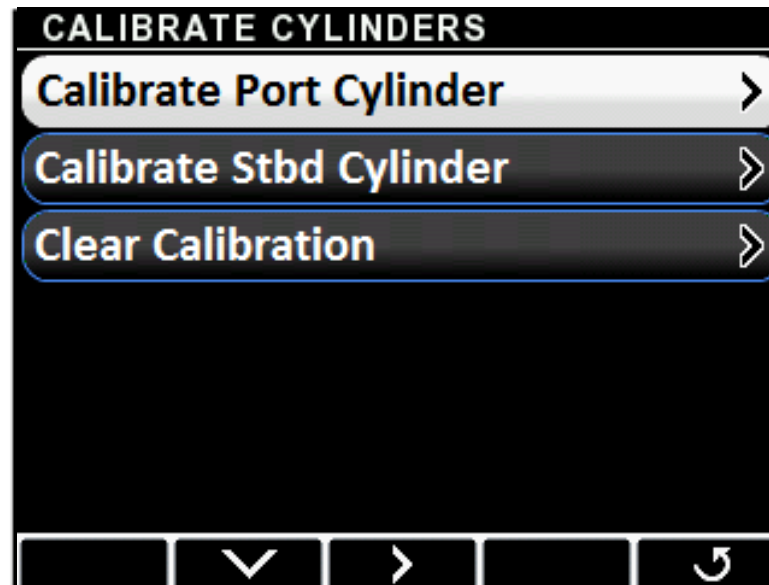

Figure 7-9.

3. Select **Calibrate Port Cylinder** and press > to enter Calibration Mode.

Optimus 360 System Calibration – Color CANtrak

NOTICE

The system uses pump current to detect hardstop, and may falsely detect a hardstop if the wheel is turned too quickly. Be sure to turn the wheel slowly and smoothly.

If the calibration shows complete and you aren't certain that you hit both hardstops, repeat the procedure.

For Datalink users: the calibration commands and RFU feedback are found on the Configuration tab of the PCM interface.

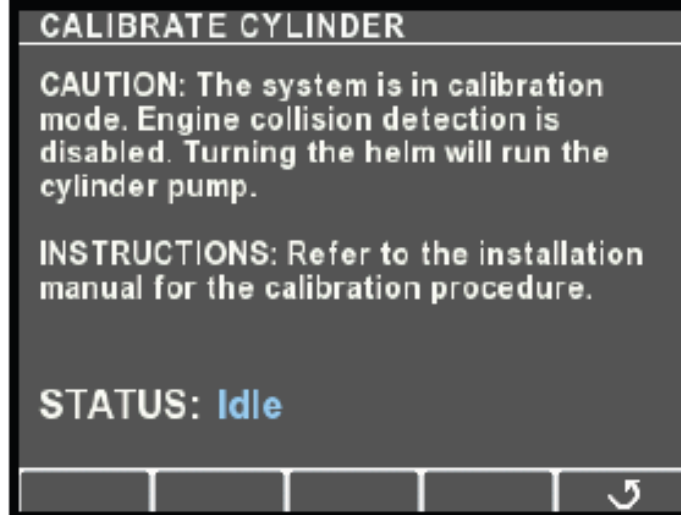



Figure 7-10.

4. Turn the helm to starboard until the status indicator reports hardstop is reached. Immediately turn the helm to port until hardstop is reported. When finished, the port engine should be turned all the way outboard. If not, turn it to the port hardstop now.
5. When calibration is complete, you will be returned to the Purge Cylinders menu.
6. Repeat the calibration procedure for the starboard cylinder.
7. When calibration is complete, press  repeatedly to exit. You will be prompted to perform a key cycle in order to save the calibration and exit the steering setup.
8. Power up the system and turn the helm. The engines should align automatically, and the steering should operate normally. If the system reports a calibration error you will need to re-calibrate the indicated cylinder.