

MEMBER  
**ABYC**  
Setting Standards for Safer Boating

9.1

NINE POINT ONE  
ISO 9001

**BAYSTAR™**

**CAPILANO™**

**SEASTAR™**

# INSTALLATION INSTRUCTIONS

## AND OWNER'S MANUAL

[www.seastarsolutions.com](http://www.seastarsolutions.com)



# **SEASTAR™**

---

Liquid Alignment/Tiebar Valve  
for SeaStar Solutions Hydraulic  
Steering Systems

---





*Before you do it your way,  
please try it our way*

# Notice to Boat Manufacturer or Installer

Throughout this publication, Warnings and Cautions (accompanied by the International Hazard Symbol ) are used to alert the manufacturer or installer to special instructions concerning a particular service or operation that may be hazardous if performed incorrectly or carelessly.

## Observe Them Carefully!

These “safety alerts” alone, cannot eliminate the hazards that they signal. Strict compliance to these special instructions when performing the installation and maintenance plus “common sense” operation are major accident prevention measures.

 DANGER	 WARNING	 CAUTION	NOTICE
Immediate hazards which <b>WILL</b> result in severe personal injury or death.	Hazards or unsafe practices which <b>COULD</b> result in severe personal injury or death.	Hazards or unsafe practices which <b>COULD</b> result in minor injury or product or property damage.	Information which is important to proper installation or maintenance, but is not hazard-related.

## WARNING

**Cleaning fluids containing ammonia, acids or any other corrosive ingredients MUST NOT be used for cleaning any part of this Hydraulic Steering System. Failure to comply will cause serious damage to the steering system, resulting in possible loss of steering, causing property damage, personal injury and/or death.**

## ***Don't compromise performance... use genuine SeaStar parts only!***

- SeaStar helms
- SeaStar hoses
- SeaStar Cylinders
- SeaStar Oil

Substituting non SeaStar parts in any part of the SeaStar hydraulic steering system, may seriously compromise system performance.

*Keep our waters clean for all current and future users. Dispose of ALL fluids in accordance with your local regulations.*

# SAFETY INFORMATION

## WARNING

The safety information provided below is intended to inform you of the dangers that may be present before, during and after the installation. It is critical that you read and understand ALL the points noted.

The safe operation of the steering system is dependant upon proper installation and maintenance, common sense, safe judgment and the knowledge/expertise of the operator. Every installer/user of the steering system should know the following requirements 'before' installing/using the steering system.

If you have any questions regarding any of these warnings, contact SeaStar Solutions.

To reduce risk of severe injury or death. Always wear a Coast Guard Approved personal flotation device (PFD) and use an engine shut-off cord (lanyard).

## Before installation

1. Read and understand the Installation and Owner's Manuals provided with your steering components.
2. Ensure that all components required to complete the installation are on hand (including hoses, fittings, oil and the proper tools required for the installation).
3. SeaStar components are highly engineered and safety tested to ensure system integrity, DO NOT substitute any component with non-SeaStar components as this may compromise system performance/reliability.

## Installation

1. Install components as directed in all Installation Manuals (including helm pumps, hoses and fitting kits).
2. DO NOT modify or substitute any component in any way without written consent from SeaStar Solutions.
3. Comply with all system ratings/regulations (boat/engine, U.S.C.G.).
  - Cylinder MUST be compatible with engine(s) installed.
  - Cylinder MUST be rated for use on the engine(s) installed.
4. Confirm that there is no interference between the steering cylinder(s), tiebars and the transom, splashwell, outboard engine or jackplate or any combination of these parts by performing the following steps;
  - a) With engine fully tilted DOWN, turn steering wheel from hard over to hard over and confirm that no interference occurs.
    - if using a hydraulic jack plate the above must also be performed at all the positions of the jack plate.
  - b) Repeat step 4a) with engines tilted UP.
  - c) Perform step 4a) with each engine in DOWN/UP positions confirming that independent TRIM/TILT can be done without any interference.
5. Confirm that the steering cylinder can be fully stroked in both directions as well as full tilt and trim without stretching, chafing, rubbing and/or kinking of the hydraulic hoses.
6. Confirm that extruded nylon tubing has NOT been substituted for SeaStar Steering Hose.
7. DO NOT use a wire coil type trim switch with a hydraulic steering system as the wire can wind up tight around the steering wheel shaft and prevent further steering.
8. Conduct Oil Level and System Check as outlined on page 13 of this manual.

# Safety Information Continued

**⚠ WARNING**

The safety information provided below is intended to inform you of the dangers that may be present before, during and after use. It is critical that you read and understand **ALL** the points noted.

**Prior to every use**

1. Check Fluid level in highest helm pump (see page 13 for proper fluid level setting).
2. Verify immediate steering response when turning steering wheel(s). (Ensure engine(s)/drive(s)/rudder(s) turns when steering wheel is turned.)
3. Visually inspect all steering hoses and fittings for wear, kinking and/or leaks.
4. Check for binding, loose, worn or leaking steering components.

DO NOT OPERATE BOAT IF ANY COMPONENT IS NOT IN PROPER WORKING CONDITION.

**During use**

1. WEAR A COAST GUARD-APPROVED PERSONAL FLOTATION DEVICE (PFD).
2. ATTACH ENGINE SHUT-OFF CORD (LANYARD) TO YOUR PFD.
3. Never allow anyone not familiar with the operation of the steering system operate the boat at any time.
4. Know and adhere to the operator restrictions for your area including;
  - Federal Laws/Regulations,
  - State Laws/Regulations and
  - Municipal Laws/Regulations.

DO NOT OPERATE BOAT IF ANY COMPONENT IS NOT IN PROPER WORKING CONDITION.

**After use**

1. Rinse off steering system thoroughly using 'fresh, clean water only'.
  - Cleaning fluids containing ammonia, acids or any other corrosive ingredients **MUST NOT** be used for cleaning any part of the hydraulic steering system.

**Maintenance**

1. Maintain steering system at a minimum of twice per year.
  - Refer to your steering cylinder Installation and Owner's Manual for Maintenance recommendations.

# Safety Information Continued

**! WARNING**

The safety information provided below is intended to inform you of the warning information on your products. Contact SeaStar Solutions if labels are missing.

## Important Labels

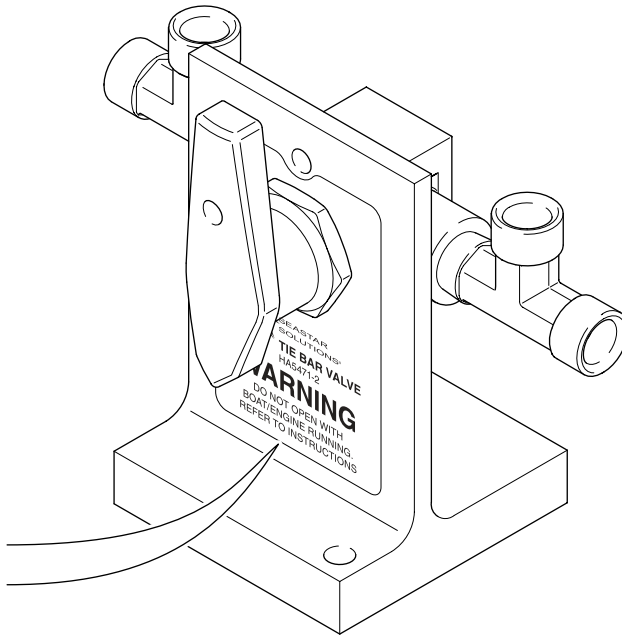

## **! WARNING**

**BEFORE ATTEMPTING THE INSTALLATION OF THE PRODUCT(S) IN THIS CARTON, READ ALL INSTRUCTIONS CAREFULLY. IF INSTRUCTIONS ARE MISSING, CONTACT SEASTAR SOLUTIONS FOR A NEW COPY, OR, VISIT [WWW.SEASTARSOLUTIONS.COM](http://WWW.SEASTARSOLUTIONS.COM). FAILURE TO ADHERE TO THESE INSTRUCTIONS MAY RESULT IN LOSS OF STEERING, LEADING TO POSSIBLE EJECTION FROM THE VESSEL CAUSING PROPERTY DAMAGE, PERSONAL INJURY AND/OR DEATH.**



**SEASTAR SOLUTIONS**

3831 No. 6 Road, Richmond BC, Canada  
V6V 1P6 Tel: 604-270-6899

326126

Figure 1. Safety labels.

**Note:** *This page left blank intentionally.*

# INTRODUCTION

Before proceeding with the installation, read these instructions thoroughly. SeaStar Solutions cannot accept responsibility for installations where instructions have not been followed, where substitute parts have been used, or where modifications have been made to our products.

## NOTICE

*There is **NO** replacement for a rigid tiebar, regardless of the application. The Liquid Alignment Valve (Liquid tiebar valve) is **ONLY** intended where a rigid tiebar is not practical and/or possible. Caution should be exercised when this valve is installed into the steering system. Read **ALL** details in this manual to understand the use of this valve and the possible problems that may arise when using this valve.*

## Index

Safety Information.....	i
Introduction .....	1
Specifications .....	2
How the System Works.....	3
Before Starting.....	4
Special Considerations.....	5
System Set-Up Quick Reference Guide.....	6
Plumbing Details .....	7
Outboard Installations .....	7
Non Power Steering Stern Drive and Inboard Powered Boats.....	8
Bleeding the Steering System .....	9
Power Purge Users – All Applications .....	9
Non-Power Purge Users – All Applications .....	11
Realignment Instructions .....	13
Oil Level System Check .....	13
Troubleshooting Guide.....	15
Statement of Limited Warranty.....	16
Return Good Procedure.....	16
Technical Support.....	16

# SPECIFICATIONS

## NOTICE

If a rigid tiebar can be installed it is suggested that this be done. The alignment valve is only intended for use where a rigid tiebar is not possible and/or practical.

The plumbing of the “Liquid Alignment Valve (liquid tiebar)” is termed “In-Series”. This should not be mistaken with a system plumbed in parallel. Use of a high displacement helm pump will cause higher effort at the steering wheel. It is suggested that the helm be matched as it would in a single cylinder application for easiest, most comfortable effort at the wheel.

## CAUTION

Use of unbalanced cylinders; such as SeaStar Side mount cylinder HC5370 can only be used in this system by orientating the steering cylinder shafts to face each other, in an outboard application this means that the port engine tilt tube will need to be reoriented to allow use of an unbalanced cylinder.

## NOTICE

Due to the mounting configuration of a power assisted STERN DRIVE Application; a liquid alignment valve (liquid tiebar) **CANNOT** be used. Consult SeaStar Solutions for options, or, install a rigid type tiebar.

## WARNING

The use of a standard helm, at high speed (55 mph +), or a high load (full throttle forward/reverse, may cause a vacuum in the liquid tie bar and cause engine/outdrives/rudders to misalign resulting in momentary loss of steering control. This will NOT occur if a SeaStar PRO helm pump is used.

Do NOT use an unbalanced cylinder with a SeaStar PRO Helm pump.

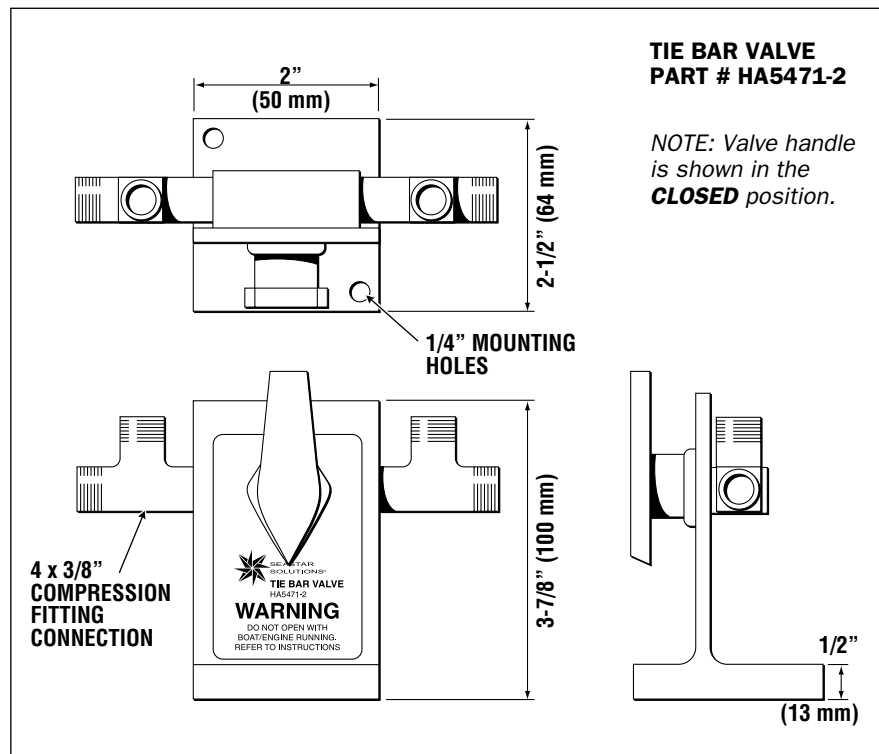

Figure 2.

## NOTICE

Mount valve in a location that is easily accessible to allow the realignment of the engines, drives or rudders. Avoid mounting the valve in an area where it may be accidentally opened under steering operation.



# HOW THE SYSTEM WORKS

The cylinder alignment valve (liquid tiebar) will allow for periodic re-alignment of twin outboard engines, twin **NON** power assisted sterndrives and/or rudders that are **NOT** linked together via a rigid tiebar. This valve will also assist in the removal of air from this type of steering system. It is suggested that a rigid tiebar be fitted in **ANY** application, where possible, to avoid the need of re-alignment of the engines/outdrives or rudders.

Due to potential leakage across the piston seals, there is no way to determine how frequently re-alignment will be required, boat use, air removal and several other conditions will play a role in the amount of times re-alignment is needed. To avoid frequent re-alignment it is suggested that you install a rigid tiebar..

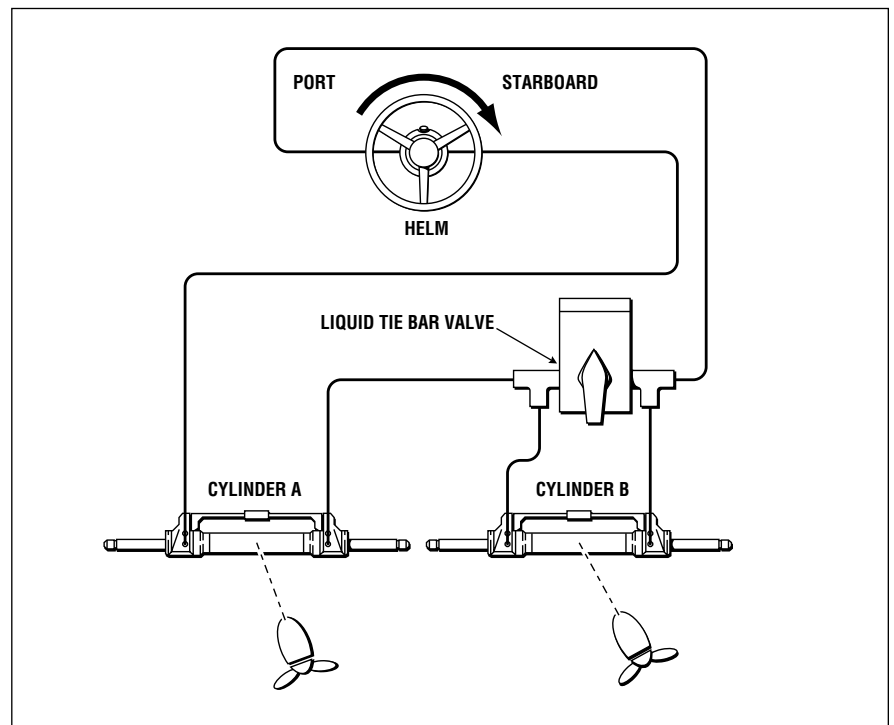

Figure 3. Front Mount Cylinder, outboard Application shown.

# BEFORE STARTING

---

Study this manual and **ALL** other manuals provided with your steering system carefully and thoroughly to familiarize yourself with **ALL** components and their intended or required mounting locations. Ensure that there is adequate space available for installation as well as easy access for usage. It is good practice to install **ALL** fittings prior to mounting units and then mount the components prior to running hose/tube. This will allow for easy hose to fitting connection, with less chance of error. If you must run hose/tube first you **MUST** close hose/tube ends with tape or similar material to prevent contamination from entering the system. **CONTAMINATION IS THE LEADING CAUSE OF A FAILURE IN ANY HYDRAULIC STEERING SYSTEM.**

Read **ALL** bold text, notes, cautions and warnings. Reading them now will help prevent unexpected surprises during installation.

These instructions have been made as complete as possible, but as brief as practical. If you have any questions, contact your Distributor or SeaStar Solutions.

## Things you need to know

### **WARNING**

**SeaStar Steering Hoses CANNOT be cut. Cutting these hoses will render them useless and a new hose will need to be ordered. Failing to comply may result in possible loss of steering causing property damage and or personal injury or death.**

### **CAUTION**

**Confirm that ALL the components needed to complete the installation are purchased, including: helm pump, Steering Cylinders, hose/tube, fluid, fittings and pipe sealant such as Loctite® PST. NEVER USE TEFLON TAPE, ONLY use the paste type pipe sealant.**

### **CAUTION**

**Take extreme care NOT to allow any foreign debris to enter the steering system.**

# SPECIAL CONSIDERATIONS

---

Special considerations must be taken into account when plumbing a system using a Liquid Tiebar Valve. These considerations are noted below with an explanation for their recommendation. Where possible these considerations should be followed to ensure the safe and proper performance of your steering system.

---

## Steering Cylinders

- SeaStar Solutions manufactures many cylinders for use in a catamaran installation. Use of these cylinders will reduce the amount of realigning of the engines, drives or rudders. Call technical support for options.
- When plumbed in “series” the helm pump only sees the volume of one cylinder. Select your helm pump as you would in a “**single cylinder application**”. Selecting the wrong pump may lead to increased effort to turn the steering wheel.
- Maintain your steering system as per your Owner’s and Installation Manual included with your steering cylinders. Doing so will increase seal life and decrease system troubles.

## Helm Pumps

- Running in reverse, or, backing down hard is known to cause a vacuum in the steering lines, resulting in fluid being pushed out of the helm pump. To prevent this use of a SeaStar PRO helm pump is recommended.

## Plumbing

- For proper operation the system MUST be plumbed as shown in this installation manual. Deviating from these plumbing schematics may result in poor, or, no steering performance.
- ONLY use SeaStar Steering hoses for steering runs below 35’. SeaStar Steering hoses are designed to provide the least amount of hose expansion possible. Use of a hose with a high expansion factor “will” result in poor performance and constant realignment of engines, drives or rudders.
- For steering runs that will exceed 35’ we recommend a combination of copper tubing and SeaStar hoses. Use of any hose in long steering runs will result in poor performance and constant realignment of engines, drives or rudders.

## SeaStar Power Assist

- SeaStar Power Assist pumps can be added to this type of system to provide easy, fingertip control. Consult with your SeaStar Power Assist Owner’s and Installation Manual for plumbing diagrams.

## Autopilots

- Autopilot systems can be used in a system such as this. Size the autopilot pump as you would in a “**single cylinder application**”.

## Removal of Air

- Failing to remove ALL the air from the system WILL result in poor performance, constant realignment and possibly oil leaking from seals. Bleeding of this system MUST be done using the instructions noted in this manual, bleeding of the system in any other fashion may NOT remove all of the air from the system.

# SYSTEM SET-UP QUICK REFERENCE GUIDE

## STEP 1 System Installation

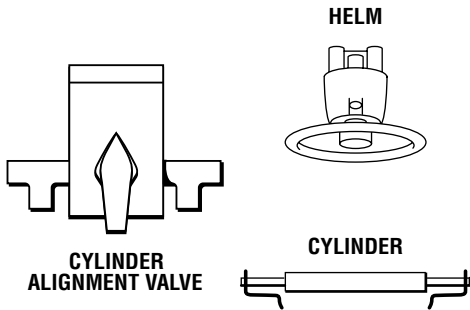

- Install SeaStar Helm pump onto the dash using installation instructions provided with your helm pump.
- Install steering cylinders using the installation instructions provided with your steering cylinders.
- Install Liquid Alignment Valve (Liquid Tiebar) in a position that allows easy access, but will not allow accidental turning of the valve hand lever.
- Install your hose/tube as detailed in the following pages.

**NOTICE** Be sure to plumb the system as per **YOUR** steering system as several different systems are noted.

## STEP 2 Filling and Purging Procedure

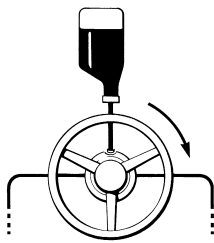

- Power Purge users. Refer to page 9 of this manual.
- Manual filling and Purging users. Refer to page 8 of this manual.
- SeaStar Power Assist users.

## STEP 3 Alignment Procedures

- Outboard installations refer to page 13 of this manual.
- Stern Drive installations refer to page 13 of this manual.
- Inboard installations refer to page 13 of this manual.

## STEP 4 System Pressure Test

- **ALL** users refer to page 13 of this manual to confirm safe and proper operation of your steering system.

### **! WARNING**

**Oil level and System check is critical to the safe operation of your boat, failure to follow this important step may lead to loss of steering control resulting in property damage, personal injury and/or death.**

# PLUMBING DETAILS

## Outboard Installations

### NOTICE

**ONLY** use SeaStar Outboard Steering Hoses or a system of copper tubing and SeaStar Outboard hoses in an outboard application, **DO NOT** use extruded Nylon tubing. Use of any other hose may affect the overall performance of the steering system, SeaStar Hoses are designed to be used in this type of system whereas other hoses may have the same operating and working pressures, they **DO NOT** have the same expansion factors and **WILL** affect the performance of the steering system.

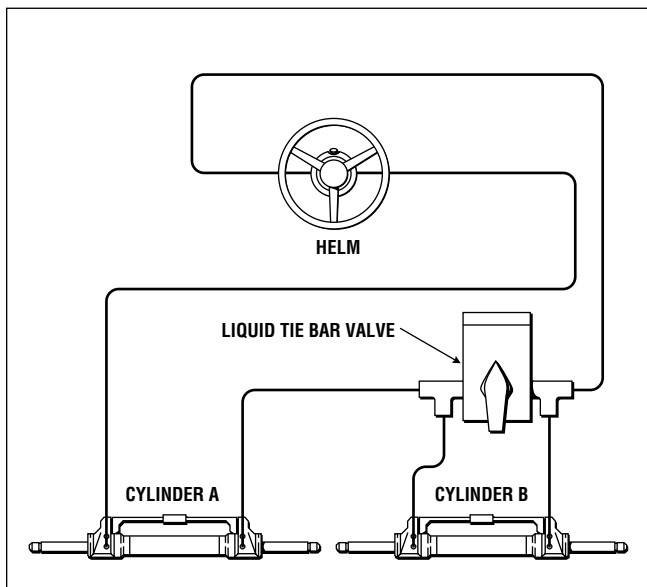

Figure 4. Front Mount Cylinder.

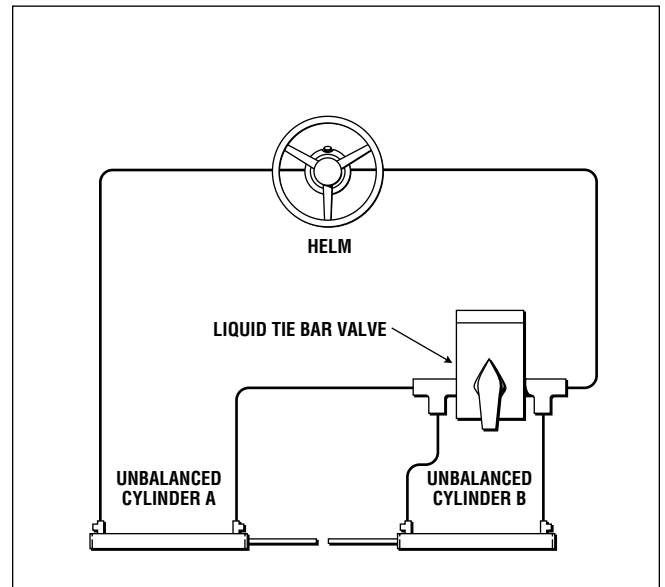

Figure 5. Side Mount (Unbalanced) Cylinder.

### NOTICE

If plumbing runs exceed 35' (one way) it is recommended that a system of 3/8" copper tube coupled with SeaStar hoses to the helm and cylinders be used.

### ⚠ WARNING

**ONLY** use SeaStar PRO, Kevlar Hoses if you are using a SeaStar PRO helm pump.

### NOTICE

#### **POWER ASSIST USERS:**

Consult Power Assist Installation Manual for plumbing details.

# INSTALLATION INSTRUCTIONS

## PLUMBING DETAILS

# Non Power Steering Stern Drive and Inboard Powered Boats

### NOTICE

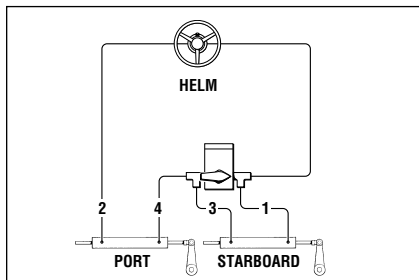

Figure 6. Stern Drive.

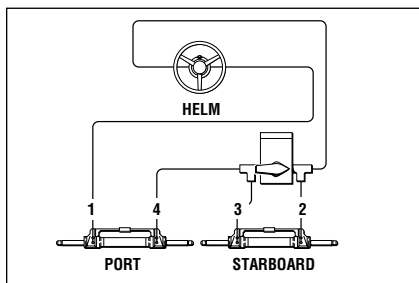

Figure 7. Front Mount Cylinder.

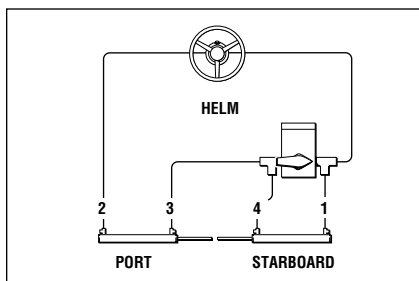

Figure 8. Side Mount Cylinder.

A liquid alignment valve (liquid tiebar) **CANNOT** be used in an engine driven power assisted system. A rigid tiebar **MUST** be fitted, or the power steering system must be removed from the boat. If you are using a SeaStar Power Steering System, i.e. Engine Driven pump, please consult your Power Steering Installation Manual for Details.

**NOTE:** If using SeaStar Stern Drive Cylinder HC5332, please refer to the front mount outboard plumbing details on page 7 of this manual.

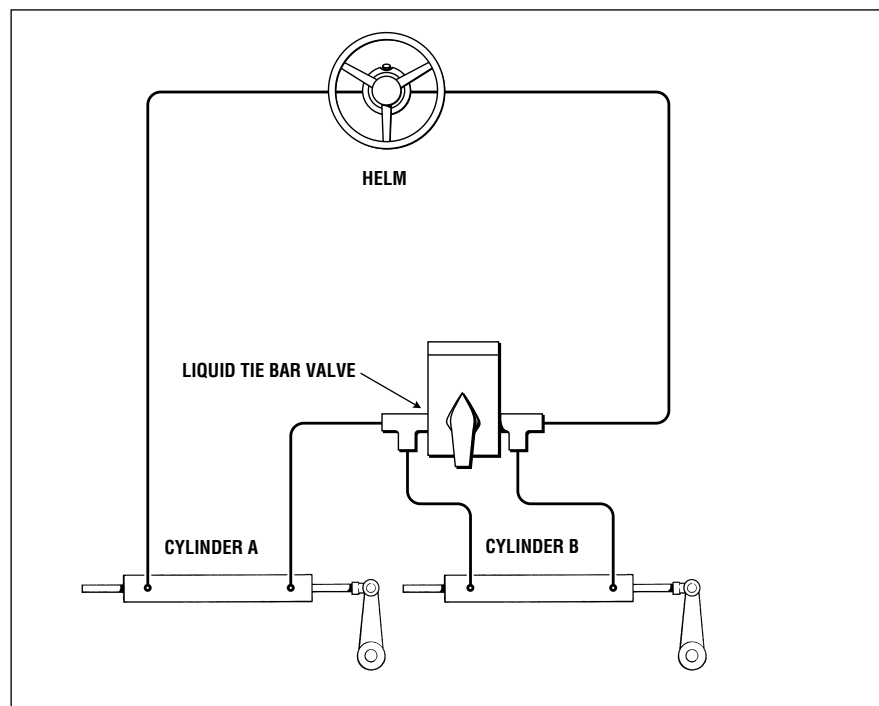

Figure 9. Stern Drive.

### NOTICE

If plumbing runs exceed 35' (one way) it is recommended that a system of 3/8" copper tube coupled with SeaStar hoses to the helm and cylinders be used.

### ⚠ WARNING

**ONLY** use SeaStar PRO, Kevlar Hoses if you are using a SeaStar PRO helm pump.

### NOTICE

#### **POWER ASSIST USERS:**

Consult Power Assist Installation Manual for plumbing details.

# BLEEDING THE STEERING SYSTEM

## Power Purge Users – All Applications

Manual bleeding procedures can be found on page 11 of this manual.

### NOTICE

If using Power Purge “dual cylinder purge kit” you may connect all lines to the bleeder fitting, however you will only be opening **ONE BLEED FITTING AT A TIME**. Opening of all four bleeders may not remove all the air from the system.

### CAUTION

Read **ALL** Notes, Cautions and Warnings that are referenced with your Power Purge Jr/Sr.

### NOTICE

Refer to the plumbing diagrams in the left hand column and locate **YOUR** plumbing details and bleeder nipple sequence. You will **NOT** remove **ALL** the air if the sequence is **NOT** followed properly.

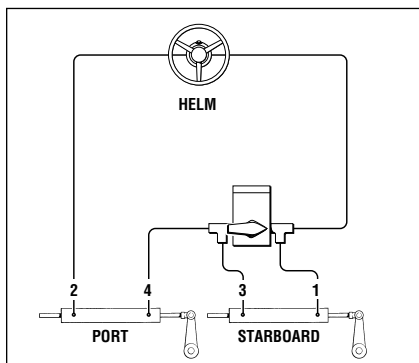

Figure 10. Stern Drive and Inboard .

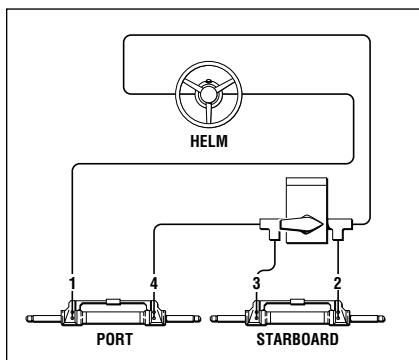

Figure 11. Front Mount Cylinder and HC5332 Sterndrive Cylinder.

1. Install helm adapter in to the fill port of the helm **and connect helm lines from Power Purge**.
  - **DO NOT** turn on the Power Purge until instructed below.
2. Connect cylinder lines from Power Purge to **Port** cylinder bleeder fittings.
3. Open **Port** cylinder bleeder fittings.
4. **OPEN** alignment valve.
5. Turn **ON** power purge and let helm fill with fluid until no air bubbles can be seen leaving the helm pump **return line**.
6. If equipped with an autopilot, with the power purge running, you will need to manually cycle the autopilot pump to port for 20 sec and then to starboard for 20 sec or until no more air bubbles are seen exiting the cylinder lines.
7. Close bleeders #2 and #4.
8. Attach **ONE** end of the cylinder line from the power purge to bleeder fitting 1. **OPEN** bleeder fitting 1.
9. Turn steering wheel clockwise until an air free stream of oil exits the bleeder fitting 1. **CLOSE** bleed fitting 1.
10. Attach **ONE** end of the cylinder line to bleeder fitting 2. **OPEN** bleeder fitting 2.
11. Turn steering wheel counter-clockwise until an air free stream of oil exits bleeder fitting 2. **CLOSE** bleeder fitting 2.
12. Attach **ONE** end of the cylinder line to bleeder fitting 3. **OPEN** bleeder fitting 3.
  - **INBOARD/STERNDRIVE**. Turn steering wheel clockwise until an air free stream of oil exits bleeder fitting 3. **CLOSE** bleeder fitting 3.
  - **OUTBOARD/HC5332**. Turn steering wheel counter-clockwise until an air free stream of oil exits bleeder fitting 3. **CLOSE** bleeder fitting 3.

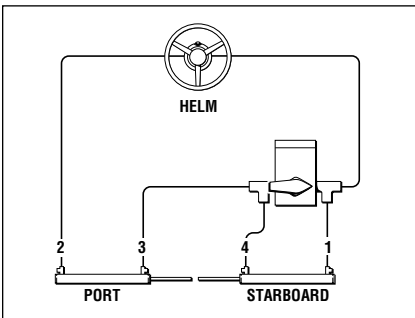

Figure 12. Side/Splashwell Mount Cylinders.

- 13.** Attach **ONE** end of the cylinder line to bleeder fitting 4.
  - INBOARD/STERNDRIVE. Turn steering wheel clockwise until an air free stream of oil exits bleeder fitting 4.
  - FRONT MOUNT OUTBOARD/HC5332. Turn steering wheel counter-clockwise until an air free stream of oil exits bleeder fitting 4.
- 14.** Turn Power purge **OFF**.
- 15.** **CLOSE** Alignment Valve.
- 16.** Remove blue hose from helm and attach the larger fitting to bleeder #3.
- 17.** Open bleeder #3 (#4 should still be open).
- 18.** Turn on Power Purge.
- 19.** Using the steering wheel, cycle the engines from lock to lock until no more air is seen exiting the cylinder.

**! WARNING**

**Ensure Power Purge fittings do not contact the engine cowling or rigging bundle or damage may occur).**

- 20.** Close bleeders #2 and #4 then turn off Power Purge.
- 21.** Remove Power purge lines from cylinders, align engines (page 13) and test system.
- 22.** Conduct Oil Level and System Check as directed on page 13.



# Non-Power Purge Users All Applications

**NOTICE**

Refer to the plumbing diagrams in the left hand column and locate **YOUR** plumbing details and bleeder nipple sequence. You will **NOT** remove **ALL** the air if the sequence is **NOT** followed properly.

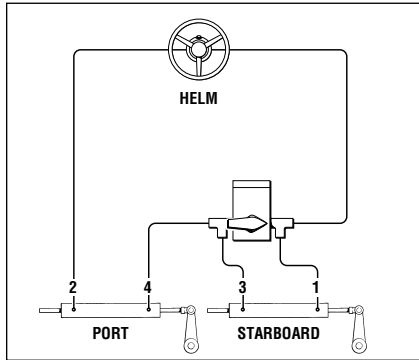

Figure 13. Stern Drive and Inboard.

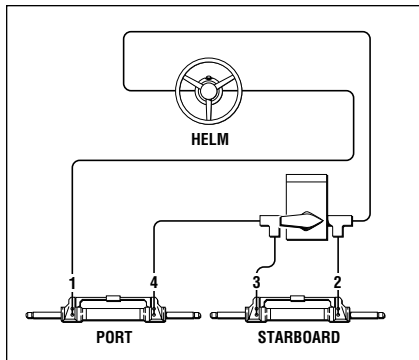

Figure 14. Front Mount Cylinder and HC5332 Sterndrive Cylinder.

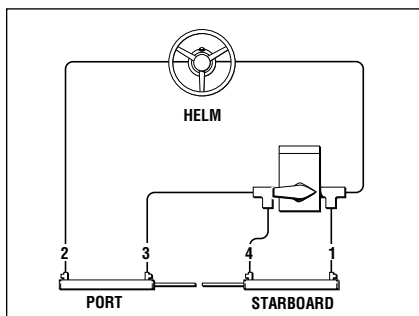

Figure 15. Side/Splashwell Mount cylinders.

1. Fill helm with oil and attach filler device/container to helm.
2. **OPEN** valve.
3. **OPEN** bleed fitting 1 and pull cylinder shaft all the way out on fitting 1 side of cylinder.
4. Turn steering wheel clockwise until an air free stream of oil comes forth from bleed fitting 1. **CLOSE** bleeder 1.
5. **OPEN** bleed fitting 2 and pull cylinder shaft all the way out on fitting 2 side of cylinder.
6. Turn steering wheel counter-clockwise until an air free stream of oil comes forth from bleed fitting 2. **CLOSE** bleed fitting 2.
7. **OPEN** bleed fitting 3 and pull cylinder shaft all the way out on fitting 3 side of cylinder.
  - INBOARD/STERNDRIVE. Turn steering wheel clockwise until an air free stream of oil exits bleeder fitting 3. **CLOSE** bleeder fitting 3.
  - OUTBOARD/HC5332. Turn steering wheel counter-clockwise until an air free stream of oil exits bleeder fitting 3. **CLOSE** bleeder fitting 3.
8. **OPEN** bleed fitting 4 and pull cylinder shaft all the way out on fitting 4 side of cylinder.
  - INBOARD/STERNDRIVE. Turn steering wheel clockwise until an air free stream of oil exits bleeder fitting 4. **CLOSE** bleeder fitting 4.
  - OUTBOARD/HC5332. Turn steering wheel counter-clockwise until an air free stream of oil exits bleeder fitting 4. **CLOSE** bleeder fitting 4.
9. **CLOSE** alignment valve.
10. Go to page 13 of this manual for realignment procedures.
11. Conduct Oil Level and System Check as directed on page 13.

**Note:** *This page left blank intentionally.*

# REALIGNMENT INSTRUCTIONS

## Engines/Drives/Rudders Toe'd outwards; Props too far apart

- Turn the steering wheel hard over to starboard (both cylinders move, starboard cylinder reaches hard over first).
- **OPEN** alignment Valve
- Continue to turn the wheel hard over to starboard until the port cylinder reaches hard over.
- **CLOSE** alignment valve.

## Engines/Drives/Rudders Toe'd inwards; Props too close together

- Turn wheel hard over to Port. (both cylinders move, port cylinder reaches hard over first).
- **OPEN** alignment valve.
- Continue to turn the wheel hard over to port until the starboard cylinder reaches hard over.
- **CLOSE** alignment valve.

## Oil Level System Check

### Step 1 – Oil level Setting

**⚠ WARNING** The oil level **MUST** be checked and maintained **BEFORE EACH** use to ensure safe steering operation. Failure to adhere to this warning may lead to loss of steering control resulting in persons being ejected from vessel or collision with an obstacle, leading to property damage, personal injury and/or death

### **⚠ CAUTION**

Side mount and Splashwell mount cylinder are unbalanced. To set the oil level in the helm pump the cylinder rod **MUST** be fully “retracted (cylinder shaft all the way in the cylinder body). Failure to adhere to this caution **WILL** result in oil spillage at the helm filler port and/or stiff steering operation.

- For helms mounted with the wheel shaft completely horizontal **MUST** be filled to the bottom of filler hole **AT ALL TIMES**. **DO NOT** allow oil level to drop more than 1/4” below filler threads.
- For helms mounted on a 20 degree angle, or, with wheel shaft in the vertical position, oil level should be within 1/2” of filler hole.

### Step 2 – System Check

**⚠ WARNING** The system check **MUST** be completed after installation. Doing so will ensure the safe operation of your steering system and will any fault/leak will show at this time. Failure to adhere to this warning/check may result in the loss of steering control leading to ejection from the vessel, or, collision with an obstacle resulting in property damage, personal injury and/or death.

- Turn steering wheel hard over to hard over to confirm unrestricted movement of the steering system and hoses. Repeat this procedure in ALL trim/tilt positions of the engine(s)/drive(s)/rudder(s). If interference occurs, or, hoses are being stretched this **MUST** be removed prior to operating your boat.

## INSTALLATION INSTRUCTIONS

### OIL LEVEL SYSTEM CHECK

- Confirm that engine(s)/drive(s)/rudder(s) are deflecting to the proper direction when steering wheel is turned.
- If no interference is noticed, or, any interference is corrected, go to next step.
- Take steering wheel hard over to starboard (any helm can be used on a multi-station boat). Once the wheel reaches its stop point (cylinder is fully stroked out), continue to force the wheel one (1) full turn past stop. Leave wheel in this position while you check all PORT side connections, fittings, seals and hoses for leaks.

**NOTICE** *This step will NOT harm the system and any noise made during this step should not be considered a fault in the steering system.*

- If leaks are noticed they MUST be repaired prior to operating boat. After repair repeat bleeding procedures as outlined in this manual.
- Repeat to the Port direction and inspect ALL starboard side connections, fittings, seals and hoses for leaks.

**NOTICE** *This step will NOT harm the system and any noise made during this step should not be considered a fault in the steering system.*

- If leaks are noticed they MUST be repaired prior to operating boat. After repair repeat bleeding procedures as outlined in this manual.

### WARNING

**Failure to complete the above noted step or, failure to correct a problem may result in loss of steering control leading to ejection from the vessel or collision with an obstacle resulting in property damage, personal injury and/or death.**

# TROUBLESHOOTING GUIDE

The SeaStar Liquid Tiebar valve will provide years of safe and reliable performance when installed and maintained correctly. Most faults occur when installation instructions are not followed and in most cases the faults will show up immediately upon filling the system. Below are the most common faults, their likely cause and possible solutions. If your fault is not covered here, or, you have gone through all possible solutions without success please contact SeaStar Solutions Technical Support for assistance. See Contact information on page 16 of this manual.

## WARNING

**Whenever a solution calls for removal from the vessel and/or dismantling of steering system components, the work must be carried out by a qualified marine mechanic only. SeaStar Solutions offers the following as a guide only and will not assume any responsibility for problems resulting from incorrect repairs.**

FAULT	CAUSE	SOLUTION
<b>1. Fluid burping out of helm filler cap.</b>	<ul style="list-style-type: none"><li>• Air in the system.</li><li>• System overfilled.</li></ul>	<ul style="list-style-type: none"><li>• Bleed system free of air using the bleeding instructions found in <b>THIS</b> manual.</li><li>• See fluid level setting on page 13 of this manual.</li></ul>
<b>2. Have to constantly realign engines/drives/rudders.</b>	<ul style="list-style-type: none"><li>• Air in the system.</li><li>• Cylinder bypassing.</li><li>• Long steering runs plumbed with hose.</li><li>• Incorrect hose/tubing being used.</li></ul>	<ul style="list-style-type: none"><li>• Bleed system free of air using the bleeding instructions found in THIS manual.</li><li>• Consult Technical Support for cylinder testing.</li><li>• See “Special Considerations” page 5 for plumbing considerations.</li><li>• See “Special Considerations” page 5 for plumbing considerations.</li></ul>
<b>3. System is very heavy to turn all the time.</b>	<ul style="list-style-type: none"><li>• Wrong helm pump selected for the application.</li><li>• Incorrect fluid being used.</li><li>• Restrictions in steering lines.</li><li>• Mechanical interference.</li></ul>	<ul style="list-style-type: none"><li>• Helm pump for twin cylinders was selected. See “Special Considerations” page 5 for helm pump considerations.</li><li>• Use SeaStar Steering Fluid only.</li><li>• Ensure steering hoses/tube show no signs of collapse or kinking. Replace hose/tube if signs of collapse or kinking is present.</li><li>• Confirm that there is no mechanical interference with steering components or any other object. Check in all possible trim/tilt positions of the engines/drives.</li></ul>

# Statement of Limited Warranty

We warrant to the original retail purchaser that **Marine Canada Acquisition Inc. DBA SEASTAR SOLUTIONS** (herein forward referred to as SEASTAR SOLUTIONS) products have been manufactured free from defects in materials and workmanship. This warranty is effective for two years from date of purchase, excepting that where **SeaStar Solutions** products are used commercially or in any rental or income producing activity, then this warranty is limited to one year from the date of purchase.

We will provide replacement product without charge, for any **SeaStar Solutions** product meeting this warranty, which is returned (freight prepaid) within the warranty period to the dealer from whom such product were purchased, or to us at the appropriate address. In such a case **SeaStar Solutions** products found to be defective and covered by this warranty, will be replaced at **SeaStar Solutions'** option, and returned to the customer.

The above quoted statement is an extract from the complete **SeaStar Solutions** products warranty statement. A complete warranty policy is available in our **SeaStar Solutions** products catalogue.

## Return Goods Procedure

Prior to returning product to **SeaStar Solutions** under warranty, please obtain a Return Goods *Authorization number* (claim number).

Be sure to label the goods with:

- a) the name and address of the sender, and
- b) the return goods authorization number (claim number)

Please address the returned goods as follows:

### **From U.S.A.**

RGA # ?  
SeaStar Solutions  
c/o UPS-SCS  
19308 70th Ave S.  
Kent, WA 98032

### **From Canada**

RGA # ?  
SeaStar Solutions  
3831 No.6 Road  
Richmond, B.C.  
Canada V6V 1P6

---

### **Technical Support**

Phone: 604-248-3858

email: [seastar@seastarsolutions.com](mailto:seastar@seastarsolutions.com)

Hours: Monday to Friday 05:00 – 15:30 PST

Web: [www.seastarsolutions.com](http://www.seastarsolutions.com)

© 1998 MARINE CANADA ACQUISITION INC.  
DBA SEASTAR SOLUTIONS

PRINTED IN CANADA 04/18

Please scan  
this QR code  
and watch our  
latest **Boating  
Safety** video.



SEASTAR SOLUTIONS  
3831 NO.6 ROAD  
RICHMOND, B.C.  
CANADA V6V 1P6

FAX 604-270-7172

**[www.seastarsolutions.com](http://www.seastarsolutions.com)**

**ISO 10592**



FORM NO. 570122 Rev. M

